



TTD™ Series Configurable Fault Annunciator

Installation and Operations Manual

In order to consistently bring you the highest quality, full-featured products, we reserve the right to change our specifications and designs at any time. The latest version of this manual can be found at www.fwmurphy.com.

Warranty - A limited warranty on materials and workmanship is given with this Murphy product. A copy of the warranty may be viewed or printed by going to <http://www.fwmurphy.com/warranty>.



Enovation Controls has made efforts to ensure the reliability of the TTD System and to recommend safe usage practices in system applications. Please note that in any application, operation and controller failures can occur. These failures may result in full control outputs or other outputs, which may cause damage to or unsafe conditions in the equipment or process connected to the TTD system.

Good engineering practices, electrical codes and insurance regulations require that you use independent external protective devices to prevent potentially dangerous or unsafe conditions. Assume that the TTD system can fail with outputs full on, outputs full off or that other unexpected conditions can occur.

Please read the following information before installing the TTD annunciator.

This installation information is intended for all TTD Series models. A visual inspection of this product before installation for any damage during shipping is recommended.

Disconnect all power and be sure machine is inoperative before beginning installation.

Installation is to be done only by qualified technician.

Observe all Warnings and Cautions at each section in these instructions.

Device shall be wired in accordance with Class I, Division 2 wiring methods.

This equipment is suitable for use in Class I, Division 2, Groups B, C and D hazardous areas.

WARNING – Explosion Hazard – Substitution of components may impair suitability for Class I, Division 2.

Please contact Enovation Controls immediately if you have any questions.

Table of Contents

Product Description	1
Display Head (TTD-H).....	1
Power Supply	1
Dimensions	2
Installation	3
Mounting the Unit	3
Installation Diagram for the TTD Display.....	4
Typical Installations for TTD Power and Control Inputs/Outputs	6
TTD G-Lead Choke Installation Instruction	9
Backup Battery Replacement.....	10
Initial Power-up	12
Product Features	13
The Display	14
Front Panel Key Functionality	15
TTD Keypad Features	15
Operational Display Messages.....	19
Backlight used as Status Indication.....	21
Configuration / Setup of the TTD Annunciator	22
Navigating the TTD Front Panel.....	22
Entering Setup Mode	23
Setup 1 – Timer Setup	25
Setup 2 – Sensor Mode	27
Setup 3 – Sensor Type	30
Setup 4 – Remote Reset Remote Lockout Select and No-Flow Enable Delay	32
Setup 5 - Hourmeters.....	34
Setup 6 – Speed Calibration	35
Setup 7 – Tachometer Overspeed Option.....	37
Setup 8 – Tachometer Underspeed Option.....	38
Setup 9 – Communication Settings	39

Setup A – Output Mode.....	40
Setup B – Unit Identification (ID)	41
Setup C – Factory Default	42
Voltage Readings.....	43
Software Version.....	44
Communications	45
Communications Port.....	45
Modbus Register Address Listings.....	46
Specifications	49
TTD Replacement Parts and Assemblies	51

Product Description

The TTD product is a solid-state fault annunciator and shut-down control system designed to protect engines, compressors and their associated equipment. The TTD monitors 48 normally open and/or normally closed sensors. Each of the 48 channels can be configured for Shutdown or Alarm Only. Any channel can be locked out by one of the two Start-Run timers or configured as Class C, ESD or Ignore. The annunciator provides logic for both closing of a fuel valve and grounding of an ignition after a time delay.

Incorporated in the TTD non-volatile memory:

- Run Hours/Elapsed Time Meter (hours roll over at 99,999)
- Last 10 Shutdowns with associated run hours
- Last 4 Alarms with associated run hours

Optional Features (Model Dependent):

- Pre/Post lube timed functionality
- Tachometer w/ Overspeed and Underspeed setpoints
- Lubricator No-Flow detection for up to 4 pulsing proximity switches

Display Head (TTD-H)

The Display Head shows operational and configuration data. Configuration parameters are entered via keypad or transferred using PC and Mconfig™ software. The operator interface will accept digital inputs directly on the back of the unit. Power is provided to the Display Head via a direct-mounted power supply or a cable connecting to a remote mounted power supply. The display head contains the microprocessor, the Liquid Crystal Display (LCD), the membrane keys for configuring the sensors inputs and the sensor input terminal blocks.

The TTD liquid crystal display annunciates any fault from the sensor channel, displays engine speed and run hours/elapsed time. Other features for the TTD model are: built-in Test Mode to test the sensor circuits without shutting down; Pre-lubrication and Post-lubrication timers; and onboard backup battery to retain the fault display after shutdown on ignition-powered units.

Power Supply

The Power Input and Control Output Terminals are mounted on the Plug-in Power Supply (PSU-2) or on the DIN Rail Power Supply (PSU-D2). The Power Supply also includes a RS485/RS232 serial communication port (MODBUS RTU slave) to interface with micro-controllers, PCs, PLCs and/or communication and control systems. The serial communication provides read and write register capability with selectable baud rates up to 38,400 bps.

All Power Supply models are reverse polarity protected and can be powered by 10-32vdc or 90- 400vdc negative ground CD ignition. An optional Power Supply (PSU-D2) provides for 120vac power/positive ground CD ignition power. Use the PSU-1* Power Supply for Division 1 applications. The TTD annunciator is fully operable with the internal battery. The external DC power enables communications support and turns on the display backlight.

Dimensions

TTD Display Head

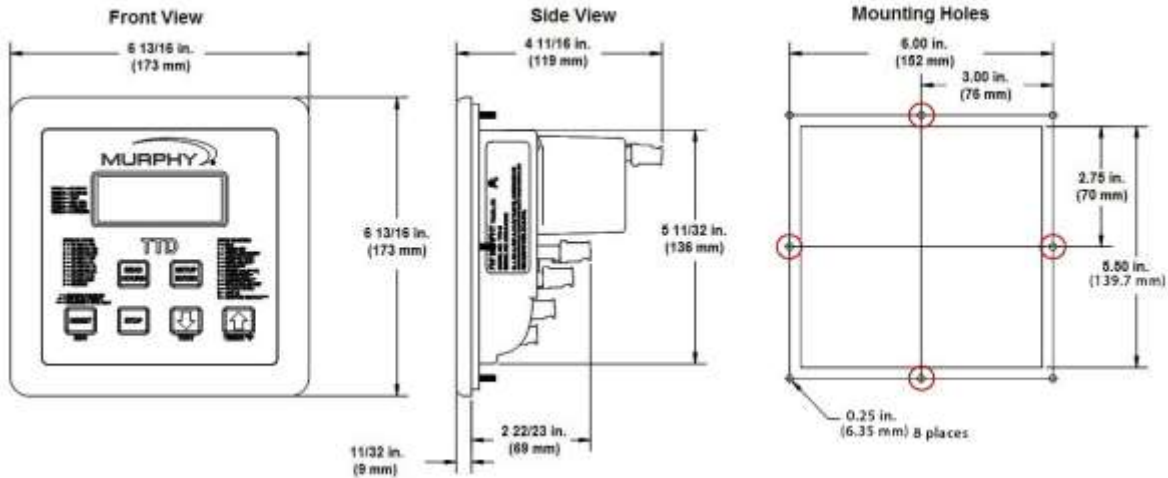

Power Supply

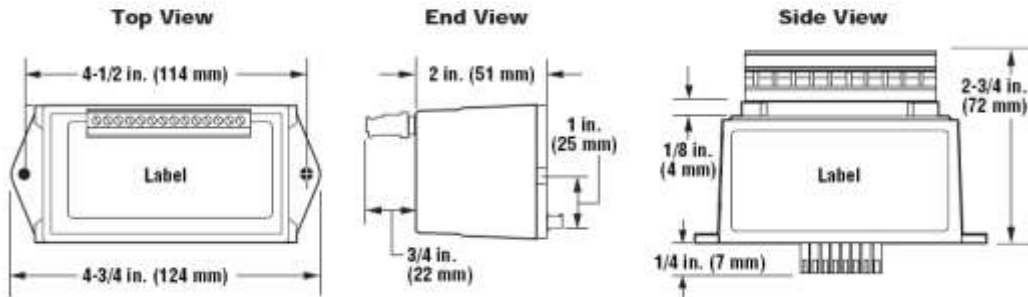

Installation

Mounting the Unit

The TTD head was designed to be mounted within a weatherproof enclosure. It is intended for mounting in a flat panel. A square mounting hole of 5-1/2 in. (140 mm) and 4 mounting screw holes are needed.

WARNING! Perform the mounting operation with power source off.

Stud Tightening Pattern

The following stud tightening instructions are required to maintain the IP66 rating when installation requires the display to be mounted in an enclosure door exposed to atmospheric conditions.

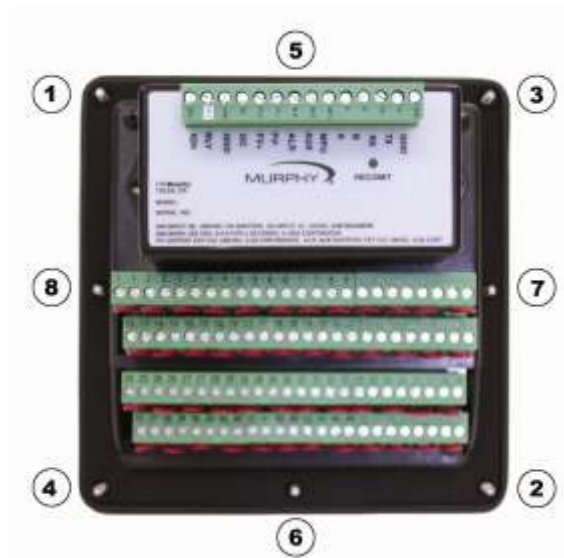

- Stud tightening pattern should be followed:
 1. Top left corner
 2. Bottom right corner
 3. Top right corner
 4. Bottom left corner
 5. Top center
 6. Bottom center
 7. Right center
 8. Left center
- Tighten holding nuts to 9 in. /lbs.

Installation Diagram for the TTD Display

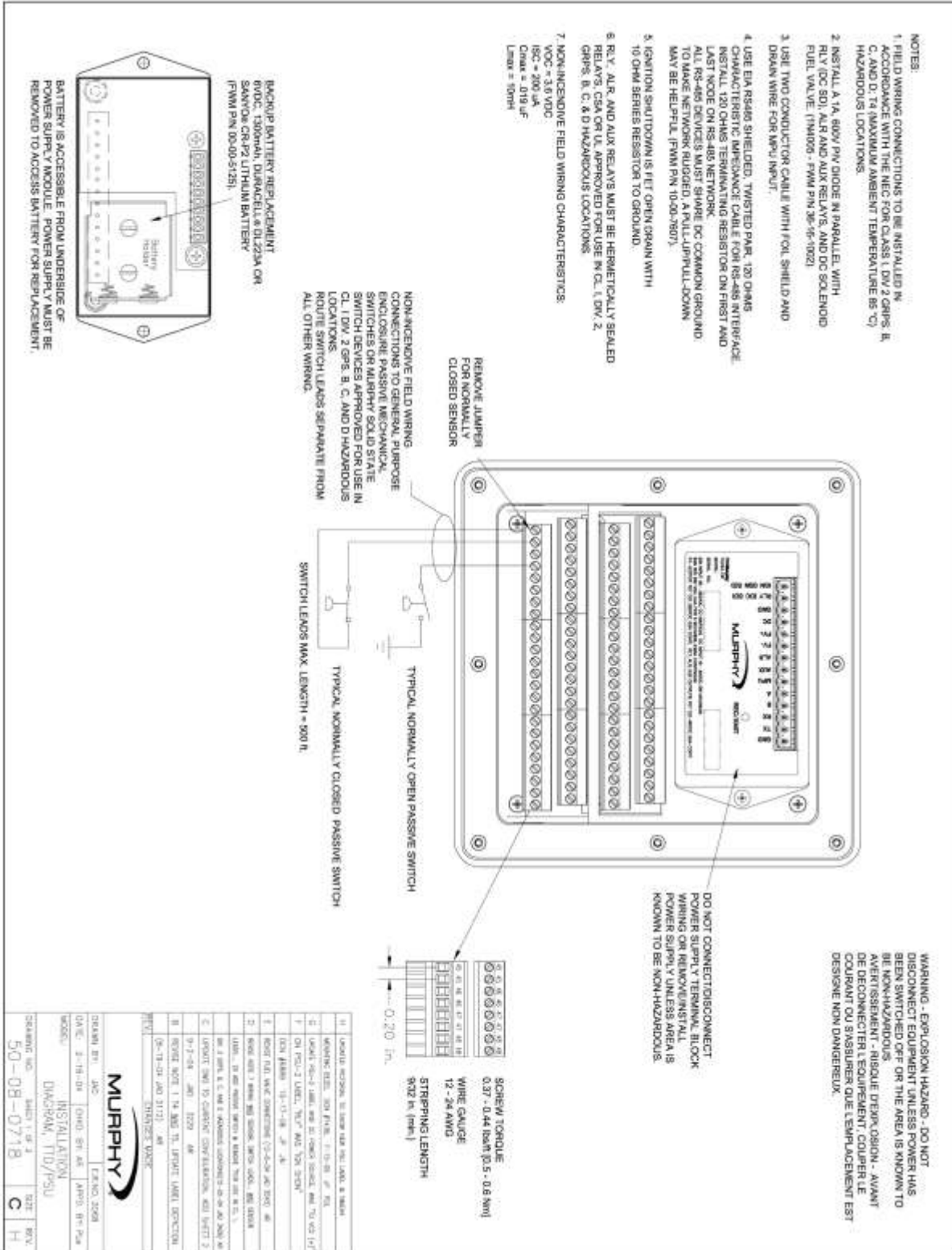

DIAGRAM B - FV TYPICAL CONNECTIONS

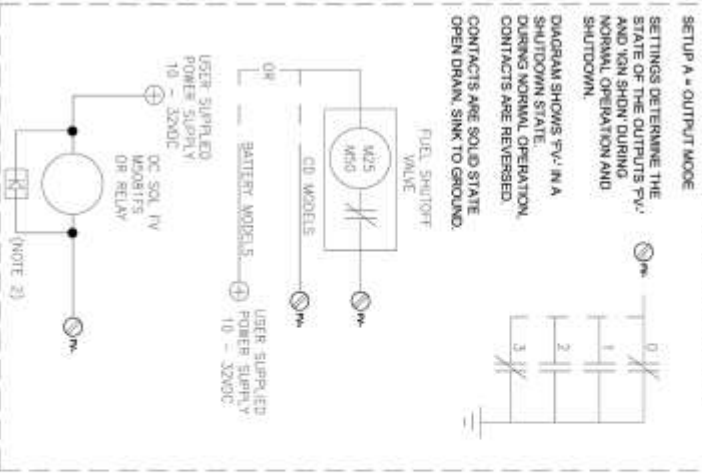

DIAGRAM C - RS-485 TYPICAL CONNECTIONS

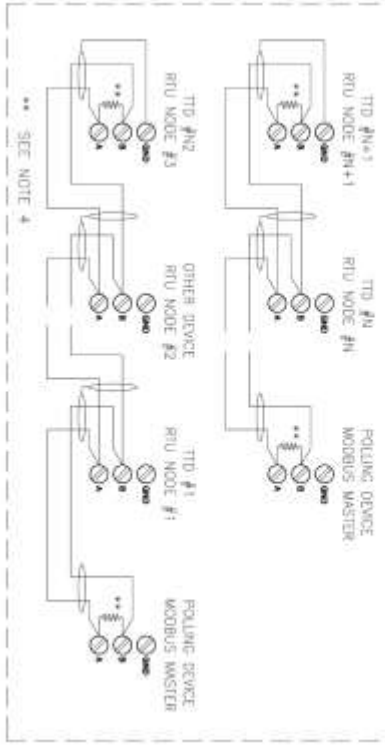
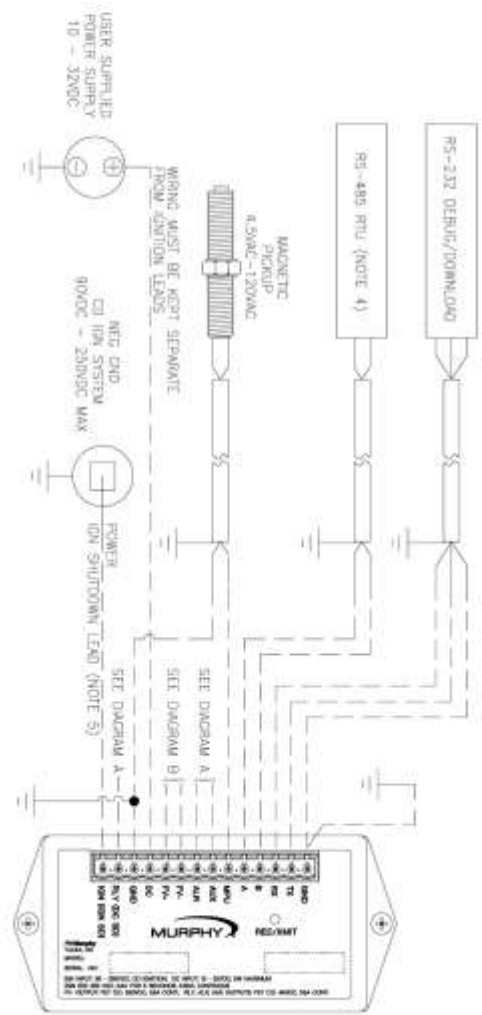
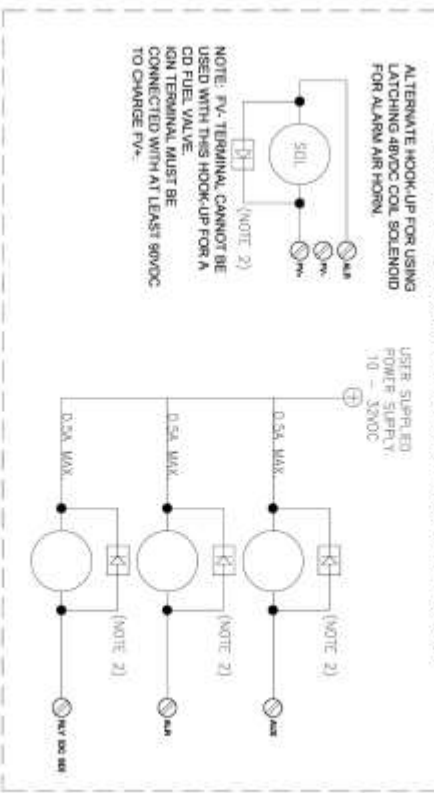

DIAGRAM A - ALR, AUX & RLY (DC SD) TYPICAL CONNECTIONS



DRAWING NO. SHEET 1 OF 2
50-08-0718 C H

Typical Installations for TTD Power and Control Inputs/Outputs

Application wiring for: Negative Ground CD Ignition Power CD Fuel Valve Ground CD Ignition

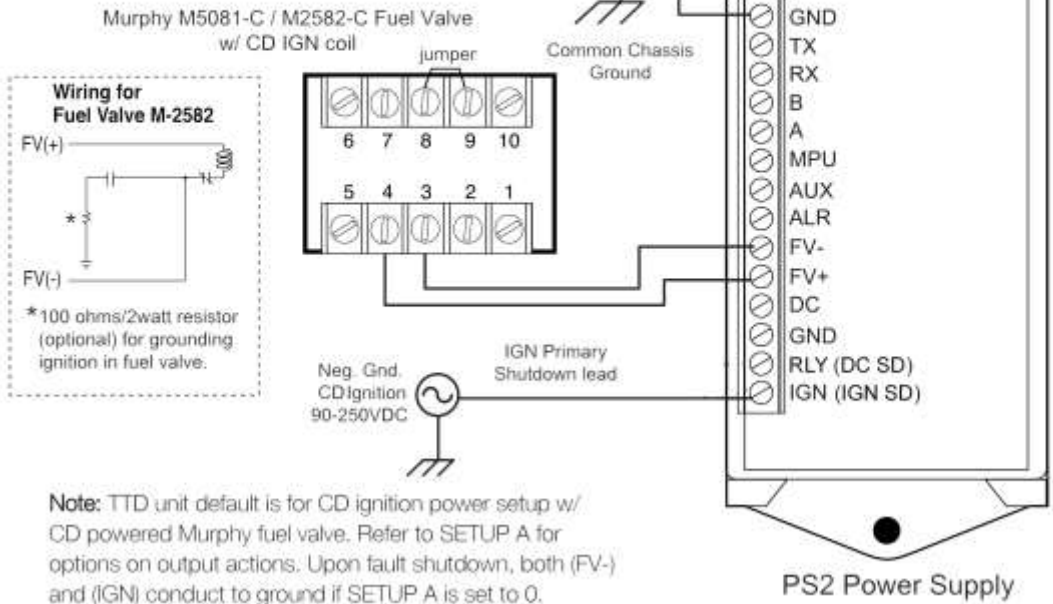

Installation for DC Power DC Ignition Relay DC (continuous duty) fuel valve Application

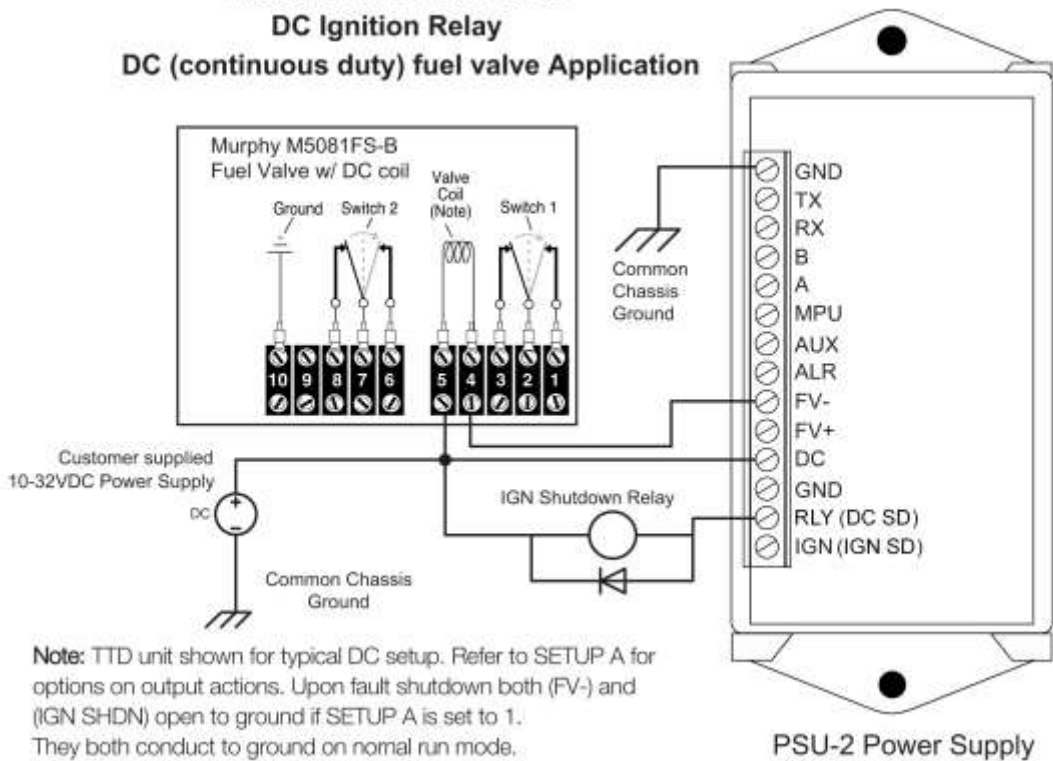

TTD Connections for Alarm, Pre/Post Lubrication Functions

Note: The (AUX) output is for turning the auxiliary lubrication pump on and off based on the setting on the **TIMER 5** and **TIMER 6** in **SETUP 1** when the unit has the Lube option. The (AUX) terminal conducts to ground when the Timers are active. When the Timers are active and the operator presses [TIMER 0], the contact will open to ground.

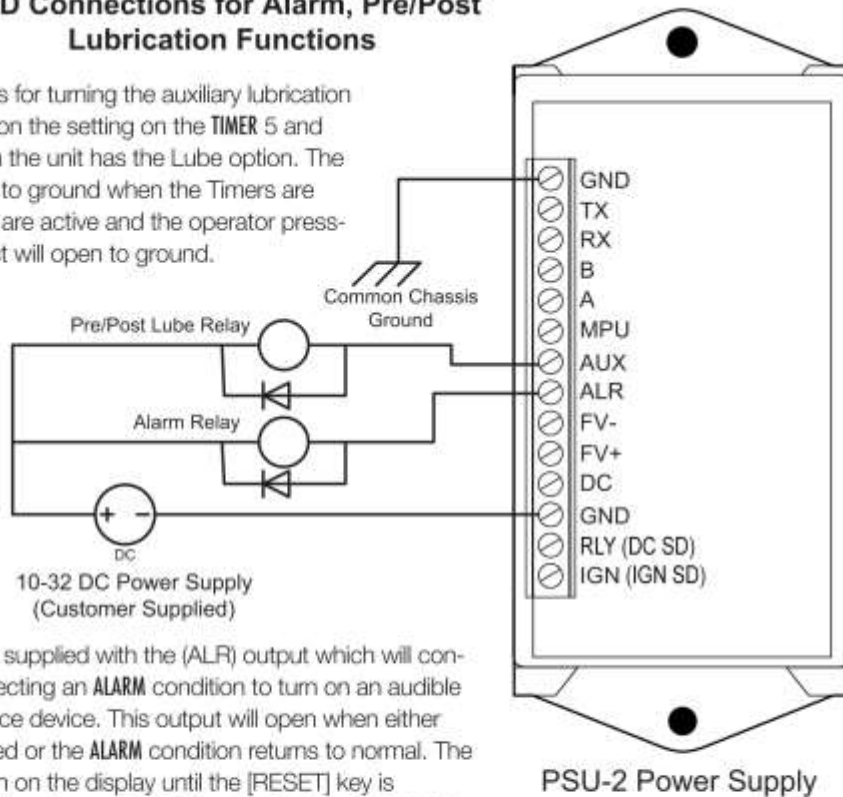

Note: TTD annunciator is supplied with the (ALR) output which will conduct to ground upon detecting an **ALARM** condition to turn on an audible horn, light or other interface device. This output will open when either the [RESET] key is pressed or the **ALARM** condition returns to normal. The **ALARM** message will remain on the display until the [RESET] key is pressed acknowledging the alarm. The (ALR) output is also energized during **SHUTDOWN**. Pushing the [STOP] key will not energize the (ALR) output.

TTD Connections for Tachometer - Hourmeter Functions

Note: When using a Murphy Magnetic sensor (pick up) model MP3298, MP7905 or MP7906 connect the wires to terminals (MPU) and (GND). Refer to **SETUP 6** for Speed calibration instructions.

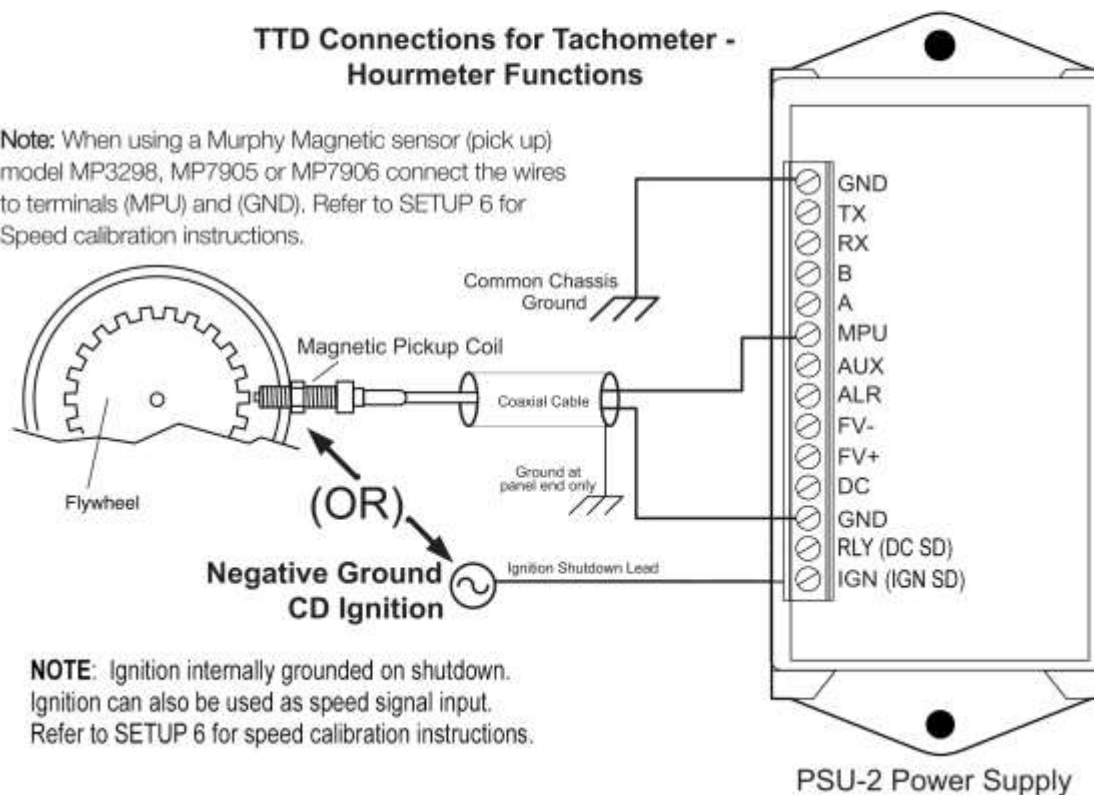

NOTE: Ignition internally grounded on shutdown. Ignition can also be used as speed signal input. Refer to **SETUP 6** for speed calibration instructions.

SETUP A = Output Mode Configuration

Upon shutdown the (FV-) fuel valve and (RLY) terminals will change stages and either conduct to ground or be open to ground. Their Mode of operation depends on the setting in SETUP A. This sketch represents the options on those settings 0 through 3.

Shutdown Mode					
Output Mode	IGN Kill	RELAY	FV-	ALR	AUX
0	Closed	Closed	Closed	Closed - alarm event Open - no event	Open
1	Open	Open	Open	Closed - alarm event Open - no event	Open
2	Closed	Closed	Open	Closed - alarm event Open - no event	Open
3	Open	Open	Closed	Closed - alarm event Open - no event	Open

Closed indicates closed to ground and open indicates open to ground state when unit is in Shutdown state.

Contacts are shown in Shutdown state.

Refer to Setup A - Output Mode section of this manual for more information on the Setup A.

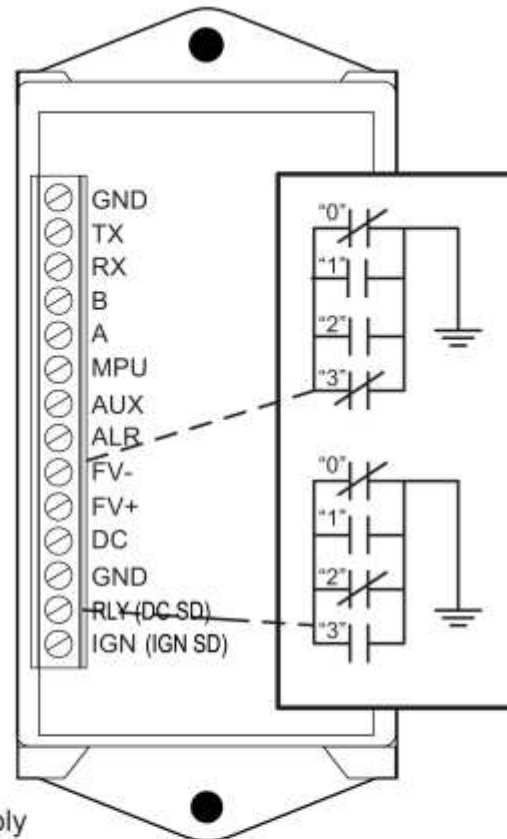

PSU-2 Power Supply

TTD Input Terminal Block Connections

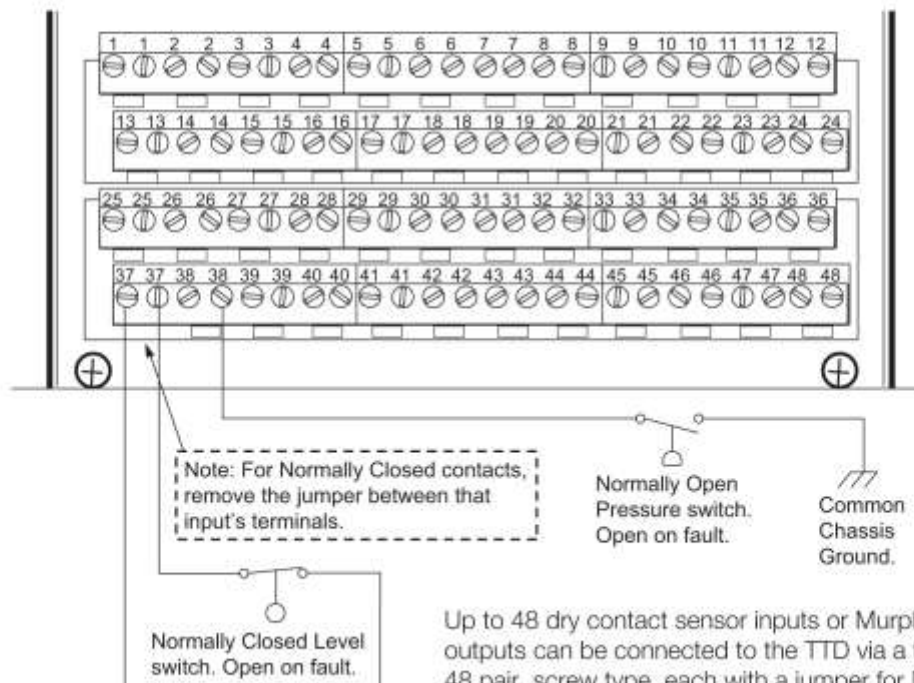





Up to 48 dry contact sensor inputs or Murphy device transistor outputs can be connected to the TTD via a terminal block with 48 pair, screw type, each with a jumper for N.O. (Normally Open) or N.C. (Normally Closed) configuration.

TTD G-Lead Choke Installation Instruction

IMPORTANT: This installation is recommended when connecting an ignition primary lead to the TTD Annunciator to avoid potential electrical noise problems. This choke has been specifically selected for the application.

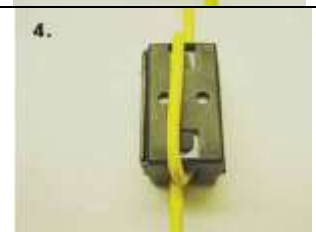
The choke (Murphy part number 50000774) is shipped with each TTD annunciator.

 <p>1.</p>	<p>1. Open the choke and lay it on the table.</p>
 <p>2.</p>	<p>2. Lay the wire across the inside of the choke as shown.</p>
 <p>3.</p>	<p>3. Wrap the wire around the outside of the choke as shown.</p>
 <p>4.</p>	<p>4. Wrap the wire back across the inside of the choke as shown. The wire should lay next to the wire from step 2.</p>
 <p>5.</p>	<p>5. While holding the wires, carefully close the choke as shown. Be careful not to pinch the wire when closing the choke.</p> <p>NOTE: Keep the wire loops on the outside of the choke as small as possible.</p>

Backup Battery Replacement



WARNING! Before disconnecting or connecting equipment, switch the power OFF and, if possible, lock it out. Assure the area is in a non-hazardous condition before beginning the installation of any new equipment or repairing existing equipment. Bypassing these precautions may present an environment in which explosive hazards are present. If you are working in a hazardous location, take the appropriate precautions to assure the safety of all personnel and equipment.

The TTD Annunciator contains a Backup Power Battery (shipped loose with the TTD Annunciator) located in the power supply module.



While this battery has a potential life of up to 1 year, it may require replacement. The LOW BATT icon will appear when the internal backup battery voltage is below 5.0 volts. If the battery is missing or the voltage falls below 4.6 volts, the LOW BATT icon will blink. Replace the battery when the LOW BATT icon displays in the lower left corner.



NOTE: Internal backup battery is not used during normal operation. Backup battery supplies power to operate TTD Annunciator when CD Ignition is the only source of power and it is not operating (Shutdown), or the user supplied +DC power source has been disconnected.

When CD Ignition or DC voltage is present, power is not consumed from the internal backup battery.

To replace the battery, follow these steps:

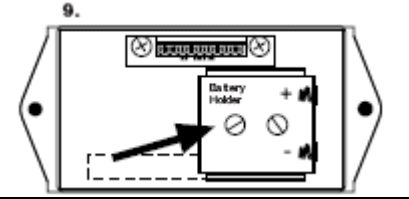
 <p>8.</p>	<p>1. Remove the Power Supply cover screws (located on the sides of the PSU-2 Power Supply).</p> <p>2. Carefully unplug the Power Supply from the Display Module.</p>
 <p>9.</p>	<p>3. Turn the Power Supply over to access the Backup Battery compartment.</p>
	<p>4. Use caution not to damage other components in the Power Supply compartment while removing and replacing the Backup Battery. Suggested replacements for the Backup Battery: 6 VDC, 1300 mAh, Duracell® DL223A or Sanyo® CRP2 lithium battery, available from Enovation Controls (p/n 00005125).</p> <p>5. Plug the Power Supply back onto the Display Module and secure the two mounting screws.</p> <p>6. Power up the system and resume normal operations.</p>

Initial Power Up

Power On Self Test (POST)

- The TTD will perform a Power On Self Test (POST) during the initial power up which will check for the following errors (in this order):
 - Low Device Voltage (code 53)
 - Crystal Failure (code 54)
 - Loss of SPI link (code 61)
- If the error is Low Device Voltage (code 53), the unit will go to the PoStErr display after testing for two seconds.
- If the error is Crystal Failure (code 54) or Loss of SPI link (code 61), the unit will reset three times to try to correct the problem. If the error is not corrected within 3 retries, the unit will go to the PoStErr display.
- The PoStErr will be displayed on the TTD as shown below :

PoStErr
XX

Where XX = 53, 54 or 61

- In the event of error code 53, the supply voltage or internal battery voltage to the annunciator will need to be verified and corrected. Once complete, unit can be reset and used for normal operation.
- Fault Code 53 will deny user access to setup menus as this represents a lack of power necessary to access the EEPROM. If the Setup Menu is accessed and a Code 53 becomes active, the user will see Err 53, and the TTD will exit the Setup Menu and return to the last state (running, stopped, etc).
- Fault code 53 will not cause a shutdown during normal operation of the TTD beyond the initial POST test.
- In the event of error codes 53, 54 or 61, which do not clear, **the entire unit (TTD and PSU) needs to be returned to Enovation Controls for evaluation.**

Product Features

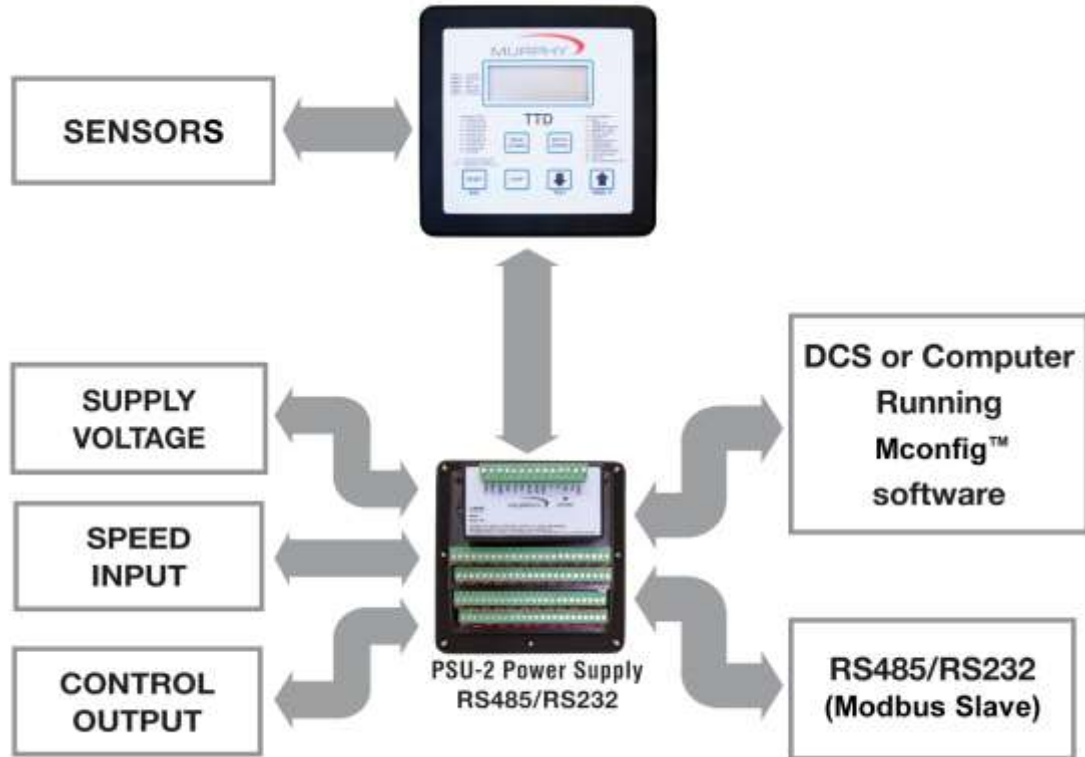

The Display

The TTD annunciator features a static LCD display (A) with backlight (external DC is required). The operating temperature is between -40° to $+85^{\circ}\text{C}$. The applicable icon and number (B, C and D) will be displayed to clarify the display readings or alert the operator to an operating condition.

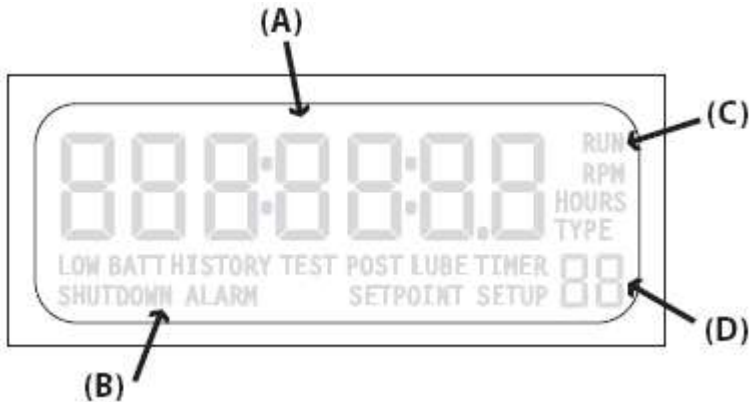

Display Icons

RUN – run mode

RPM – screen value

HOURS – screen value

TYPE – channel type configuration

LOW BATT – low battery warning (displayed if the condition exists)

HISTORY – alarm or shut-down history

TEST – test mode

LUBE – pre-lubrication timer

POSTLUBE – post-lubrication timer

SHUTDOWN – stop mode

ALARM – alarm(s) warning (displayed if the condition exists)

SETPOINT – edit setpoint value

SETUP – setup menu(s)

Front Panel Key Functionality



The operator can interface with the TTD Annunciator in one of two ways. One is via the Front Panel keypad. The second way an operator can interface is with the Murphy Mconfig™ software. This provides the user with a Template displaying the TTD Annunciator setup and status by reading the Modbus registers. Set-up selections can be made and the configuration saved to file for future reference. The software is free and can be downloaded from www.fwmurphy.com

TTD Keypad Features

NOTE: Because the keys have more than one function depending on the operational mode the system is in at the time, the following TTD Keypad Functionality blocks indicate the keypad action seen if that key is pressed. The **LOW BATT** icon can show in any mode if the battery charge is low.

Shutdown Mode

SHUTDOWN indicates the TTD identified a fault condition and alerts the operator with cause of shutdown code.

The current condition on the display indicates the **SHUTDOWN** icon is on.



	Key	Function
	Read Hours	(B) Shows the operation hours for the displayed History record*.
	Setup/Enter	Press and hold the key for 5 seconds to access the Setup Menu: The model number displays (C) and then the SETUP icon displays (D).
	Up Arrow	Shows the previous History record (E)*.
	Down Arrow	Shows the next History record*.
	Reset	Press [RESET] to start the Run Mode.

*When not in the Setup Mode, History contains records for last 10 shutdowns and last 4 alarms.

Run Mode

The condition on the display indicates the **RUN** and **RPM** icons are shown and the **ALARM** icon may be on.



	Key	Function
(G) (H)	Read Hours	(G) Shows the current operation hours. RUN icon indicates the hour meter is in increment mode.
	Setup/Enter	Press and hold the key for 5 seconds to access the Setup Menu: The model number displays and then the SETUP icon displays.
	Timer 0 / Up Arrow	Press [TIMER 0] to clear the active displayed timer. For example: B1, B2 and other timers. Also used for exiting or ending test mode operation.
	Test / Down Arrow	Press [TEST] to enable the Test Mode timer. Also used for extending or resetting the test timer. (H)
	Reset	Press [RESET] to reset the active displayed timer. <u>DO NOT</u> use to reset Test Mode Timer. This reset button will reset all class lockout timers.
	Stop	Press [STOP] to begin the Shut-down sequence.

Setup Mode – Menus

The condition on the display indicates the **RUN** and **SHUTDOWN** icons may be on.



Key	Function
Setup/Enter	If the unit is in SETUP 0, pressing [ENTER] exits the unit from the Setup Mode. If the unit is in any other Setup, pressing [ENTER] accesses the submenu for that Setup.
Up Arrow	Press [UP ARROW] to navigate to the next menu.
Down Arrow	Press [DOWN ARROW] to navigate to the previous menu.
Reset/ESC	Press [ESC] to exit from the Setup Menu and return to the operational display for the current mode.
Stop	If the system is in Run Mode, pressing and holding the [STOP] key for 2 seconds will begin the Shut-down sequence.

Setup Mode – Edit Settings

The condition on the display indicates the **SETUP** icon shows, and either the **RUN** or **SHUTDOWN** icons may show.















Key	Function
Setup/Enter	Press [ENTER] to exit or advance a Setup menu and save changes.
Up Arrow	Press [UP ARROW] to increment the value to the maximum range. Holding the key accelerates the incrementing action.
Down Arrow	Press [DOWN ARROW] to decrement the value to the minimum range. Holding the key accelerates the decrementing action.
Reset/ESC	Press [ESC] to exit or advance the Setup Menu without saving your changes.
Stop	If the system is in Run Mode, pressing and holding the [STOP] key for 2 seconds will begin the Shut-down sequence.

NOTE: Editing of selected setpoints can be accomplished during run mode. Please note these changes will **NOT** take effect until unit has returned to a Shutdown state. During the Shutdown state, these settings are written to the EEPROM, which stores settings for operation. This EEPROM **CANNOT** be written to during a Run operation.

Operational Display Messages

Several messages display during the start-up and run sequence. This tutorial shows the screens that will display as the system starts. With the unit in shut-down state and ready to start, press the [RESET] key. If Class A channels are not faulted and the unit is equipped with the Pre/Post Lube option, the unit goes into the Pre-Lube cycle. If the unit does not have the Pre-Lube option, it will go to the B1 Timer display.

<p>Pre-lubrication Timer Reading</p> 	<p>Lube Timer 5 shows the remaining time on the cycle and the LUBE icon shows on the display. The Pre-Lube cycle can be completed either by the timer reaching zero or by the operator pressing [TIMER 0]. Pressing the [TIMER 0] key will zero the time on the active visible timer only. All other active undisplayed timers will remain the same. All outputs are in a shut-down state during LUBE TIMER</p>
<p>B1 Timer Reading</p> 	<p>Once the Pre-Lube cycle completes, the outputs change state, and the B1 and B2 timers start. This display shows TIMER 1 as the remaining B1 time counts down. If this is a TTD unit with optional Tachometer, the display alternates between the active TIMER and RPM readings. If the TTD unit does not have Tachometer, the active TIMER reading alternates with the HOURS reading.</p>
<p>B2 Timer Reading</p> 	<p>Once the B1 Timer finishes, any time remaining on the B2 timer will show in the display, and the TIMER 2 icon will be visible in the lower right-hand corner of the display.</p>
<p>RPM Reading - Shows RPM**- Run Mode</p> 	<p>On TTD models supplied with tachometer, once the B1 and B2 timers have expired, the unit goes to a normal Run Mode. Both the RUN and RPM icons will be visible, and the display gives the RPM reading. TTD units without the Tachometer display the HOURS reading.</p>
	<p>Any conditions such as LOW BATT or ALARM alert the operator by having the icon show on the display. LOW BATT indicates low voltage on the Backup battery and may indicate it is time to replace the battery.</p>
<p>Ignition Delay Timer Reading</p> 	<p>At the detection of a fault, the TTD annunciator starts the shut-down sequence. The ignition delay timer shows the time remaining on the timer before the ignition is grounded or turned off. In addition, the fault channel shows on the left side of the display and flashes.</p>
<p>Post-lubrication Timer Reading</p> 	<p>If the TTD annunciator is equipped with the Pre/Post Lube option and there is time remaining in the sequence, the POSTLUBE icon, and the TIMER 6 icon displays showing the remaining time on the timer.</p>

<p>Shutdown Code - Shows Channel Tripped</p> 	<p>When the Post-Lube time counts down, the Fault Channel numeric display moves to the right. The HISTORY icon is visible, and the current shutdown is indicated in the lower right-hand corner by 01. This is the only time History records are available from the Front panel. History records can be read via the Modbus registers at any time.</p>
<p>Hourmeter Reading @ Shutdown Record #1</p> 	<p>The TTD annunciator stores the Shutdown and Alarm History. The last 10 shut-down codes and 4 alarms are stored with the hourmeter reading when they occur. For example, if the unit is shut-down from sensor input 35, the display shows 01 in the lower right-hand corner of the display to indicate the last shutdown, and the SHUTDOWN icon shows. Press the [UP ARROW] key to see the History of the last 10 shutdowns. For more information, see Accessing Shutdown & Alarm History.</p>
<p>Hourmeter Reading - Running Hours</p> 	<p>If this is a TTD unit with Tachometer option and the unit is in the Run Mode, when the [READ HOURS] key is pressed, the display shows the running hours for 5 seconds. The display then returns to the RPM reading.</p>
<p>Run Mode Showing RPM Reading</p> 	
<p>Test Timer Reading</p> 	<p>Push the [TEST] key to start the Test Timer for up to 5 minutes. The TEST icon shows in the display. Test Mode allows the operator to simulate faults without the outputs changing state. In Test Mode, all other functions operate normally. Faulted inputs display, but the system is not shut-down, and the ALARM is not turned on. When more time is needed to simulate inputs, the operator can press [TEST] again for up to an additional 5 minutes of time. Press [RESET] to reset the fault and then press the [TIMER 0] to exit the Test Timer. These shutdowns override Test Mode:</p> <ul style="list-style-type: none"> - Emergency Shutdown (47,48) - Overspeed (50) - Manual Stop (52) - Underspeed (51) - Loss of Ignition (49) - Optional Additional ESD, if chosen as ESD <p>If Class C functions are used, they will need to be bypassed to test other sensors. When exiting Test Mode with Class C functions, press the [RESET] and [TIMER 0] keys simultaneously.</p>
<p>Alarm Code - Shows the Channel Tripped</p> 	<p>In an alarm situation, the ALARM icon is turned on, and the alarm point or channel displays. If the unit is equipped with a Tachometer option, the active point or channel alternates with the running hours at the time of the alarm. If a fault is detected or an alarm occurs, the appropriate fault codes display</p>

Fault Codes

Fault Codes	Description
1-48	Indicates the channel that has faulted or alarmed
49	Loss of Ignition (When the CD ignition falls below 90 VDC± 10%, the firmware activates the fault)
50	Overspeed
51	Underspeed
52	Manual Stop
53	Low Device Voltage (internal diagnostic)
54	Crystal Failure (internal diagnostic)
60	Watchdog Timer
61	Loss of SPI Link (internal diagnostic)
62	Low DC Voltage (Alarm)
63	Low Backup Battery (Alarm)

Backlight used as Status Indication

If AC or DC power is connected, the backlight functionality is implemented on Div. 2 power supplies.

Run Mode – The backlight will be yellow under this condition.

Shutdown Mode – The backlight will turn red under this condition. When a shut-down fault is detected, the backlight will blink. The backlight blinking continues for 5 minutes and can be aborted if the user presses any key. After 5 minutes, the backlight stays red. During manual shut-down sequence, the backlight will be red.

Configuration / Setup of the TTD Annunciator



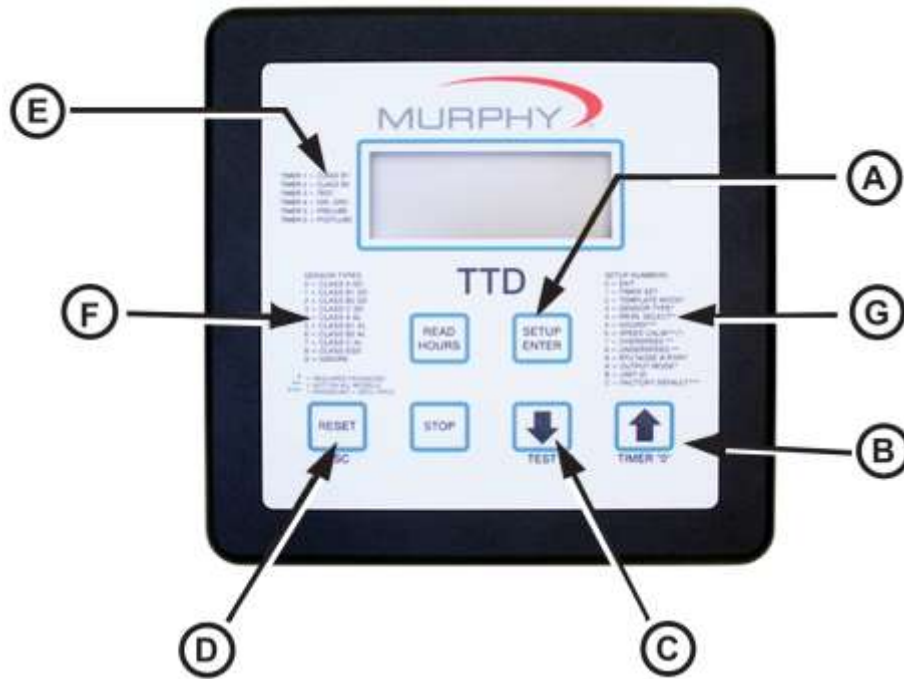

Navigating the TTD Front Panel



The TTD Annunciator can be set up by using the Front Panel. The Setup Mode can be entered from either **RUN** or **SHUTDOWN**. However, settings can only be changed when the **SETUP** icon is blinking.

- (A) [SETUP or ENTER] key
- (B) [UP ARROW] key
- (C) [DOWN ARROW] key
- (D) [ESC] escape key
- (E) Timer information
- (F) Sensor types
- (G) Setup numbers

Entering Setup Mode

 <p>The display shows 'HOLD 00:05' with a countdown timer. Below the display are menu options: LOW BATT, HISTORY, TEST, POST LUBE, TIMER, SHUTDOWN ALARM, SETPOINT, and SETUP.</p>	<p>To enter the Setup Mode, press the [SETUP/ENTER] key and hold until the display shows HOLD. Continue to press the [SETUP/ENTER] key until the model number is displayed.</p>
 <p>The display shows '00000000' with a model number. Below the display are menu options: LOW BATT, HISTORY, TEST, POST LUBE, TIMER, SHUTDOWN ALARM, SETPOINT, and SETUP.</p>	<p>The HOLD display counts down for 6 seconds, shows the model number for 3 seconds and then shows SETUP 0 to indicate the unit is in Setup Mode. Press the [UP ARROW] or [DOWN ARROW] key to move through the Setup values.</p>
 <p>The display shows 'SETUP 00' with a Setup value. Below the display are menu options: LOW BATT, HISTORY, TEST, POST LUBE, TIMER, SHUTDOWN ALARM, SETPOINT, and SETUP.</p>	<p>After selecting a different Setup to view, press the [SETUP/ENTER] key to display the current configuration of that set up value. To change a setting, press [SETUP/ENTER] again to access the menu choices. Enter changes by using the [UP ARROW] or [DOWN ARROW] key. The only time a new value can be entered is when the Setup icon is blinking.</p>
 <p>The display shows 'SAVE 000' with a new value. Below the display are menu options: LOW BATT, HISTORY, TEST, POST LUBE, TIMER, SHUTDOWN ALARM, SETPOINT, and SETUP.</p>	<p>Press the [SETUP/ENTER] key again to save the new value. The display will show SAVE for a few seconds and then return to the Setup menu.</p>
 <p>The display shows 'ESC 0000' with an exit message. Below the display are menu options: LOW BATT, HISTORY, TEST, POST LUBE, TIMER, SHUTDOWN ALARM, SETPOINT, and SETUP.</p>	<p>To exit without saving the change, press [ESC]. Press [ESC] again to exit from the Setup Mode completely. The display will show ESC and then return to the operational screen.</p>

Access During Run and Shutdown

Setup menus and settings can be viewed during **RUN** or **SHUTDOWN**, but most menus cannot be changed while in Run Mode. To assure changes can be made, access Setup menus while in Shutdown Mode. Press and hold the [SETUP/ENTER] key for 6 seconds to enter the Setup Mode. The display shows HOLD while the seconds count down.

When the countdown completes, the TTD annunciator is in Setup Mode. The unit model message displays for about 3 seconds before the SETUP 0 message shows. At this point, use the [UP ARROW] key to increment to another Setup Mode.

Password Protected Settings



THIS SYMBOL INDICATES PASSWORD PROTECTED

(M)



Some settings are password protected. If a password is required to change a setting, CODE 00 displays indicating a numeric password should be entered (M). If an incorrect password is entered, ERROR (N) displays for a few seconds, and then the CODE 00 (M) notation returns to the display.

(N)



The password will only need to be entered once during any editing session. The password is reset when the editing session is exited or is timed-out due to keypad inactivity. Entering a code 0, allows read-only access to Setup menus.

Use the [UP ARROW] and/or [DOWN ARROW] keys to enter the numeric password specific to that TTD annunciator.

Inactivity Time Out

(O)



Set up procedures need to be started and completed in a timely manner.

If the TTD annunciator is in any Setup Mode, the display function returns to the previous level of entry if there are no key presses within 30 seconds. For example, the TTD annunciator is in SETUP 3 (O), channel 25 is selected and the choice of Sensor Type is displayed (P). After 30 seconds of keypad inactivity, the TTD returns to SETUP 3 (Q).

(P)



If another 30 seconds pass with no keypad activity, escape is activated, and the unit returns to the operational screens.

(Q)



Setup 1 – Timer Setup



THIS SYMBOL INDICATES EDITING DURING RUN MODE ALLOWED

(R)



This manual explains Setup values in order starting with SETUP 1. However, once the SETUP icon is blinking, the [UP ARROW] or [DOWN ARROW] keys can be used to increment to any Setup option. Once the option is reached, press the [SETUP/ENTER] key to access the adjustments for that Setup.

(S)



All timers are configured in SETUP 1. (R) When the SETUP icon is blinking, press the [SETUP/ENTER] key to reach the specific timer to be set. (Setup icon should blink about once a second.)

Use the [UP ARROW] or [DOWN ARROW] keys to change the configuration. Once the change is completed, press the [ENTER] key to save the changes. The unit will display SAVE (S) for few seconds, and then

move to the next timer.

If a change is made and the [ESC] key is pressed, the TTD moves to the next timer without accepting the change. If no changes were made to the setting, press the [ESC] key to return to SETUP 1, or press [ENTER] to move to the next timer.

Continue to press [ENTER] to move through all timers and review values or make changes to values as necessary.

Timer 7 Delay Before No-Flow Shutdown

(T)



When an internal input detects a No-Flow condition, the Channel number that detected the condition is displayed along with Timer 7 and its countdown.

(T) Shows the Timer 7 display during No-flow delay before shutdown.

(U) Shows Setup 1 – Timer 7 menu.

(U)



Timer 7 will not be armed until Timer 1 has expired. During Timer 1 countdown, the channels enabled as No-Flow (CH41 - CH44) will be ignored.

Setting Timer 7 to zero (Ø) will cause an immediate shutdown when Timer 1 has expired, if No-Flow is detected on any of the four enabled channels.

To enable or disable the No-Flow function use SETUP 4b thru 4E.

The active timer is indicated by the **TIMER** icon (A), timer number (B) and numeric display (C).

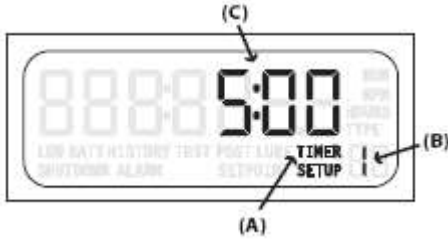

Timer	Timer Class	Timer Range
Timer 1	Class B1	0 to 5 minutes
Timer 2	Class B2	0 to 10 minutes
Timer 3	Test	0 to 5 minutes
Timer 4	IGN GND	0 to 20 seconds
Timer 5*	Pre-lube	0 to 5 minutes
Timer 6*	Post-lube	0 to 10 minutes
Timer 7**	Delay Before No-Flow Shd.	0 to 10 minutes

* When timer is set to zero (0), the Timer's feature is disabled or turned off.

** Delay-Only Timer: it does not enable or disable No-Flow functionality.

NOTE: During Run Mode if more than one Timer is active at the same time, the Timers will be displayed by the TTD in the following priority:

1. Timer 3
2. Timer 1
3. Timer 2
4. Timer 7

Timers not active during the Run Mode will not occur at the same time.

Setup 2 – Sensor Mode



(D)



(D) SETUP 2 is a feature that offers choices for predetermined configurations of sensor class to input channel. These choices can emulate an existing annunciator being replaced or configure a new installation by using the closest template. Units from the factory are set to an Emulation Template default of 1 with all inputs set to Class A.

(F)



Once the unit is in Shutdown Mode, enter SETUP 2 and choose from one of the eight pre-configured Emulation Template Settings or chose 0 and configure each individual sensor channel per your specifications/ requirements. Review the template settings in the first column of the Emulation Table and enter that number to

select the template. (F)

Emulation Table

TEMPLATE SETTINGS	B1 Lockout	B2 Lockout	Class A	Class C	Over speed	Remote Reset	Remote Lockout	Local ESD	Remote ESD		
0	<i>Only when SETUP 2 is set to "0" can individual channels be set in SETUP 3</i>										
1	TTD	Default	N/A	N/A	(1-46)	N/A	N/A	(45*)	(46*)	(47)**	(48**)
2	TTD	Mark II	8 (16-23)	N/A	32 (1-15, 24-40)	4 (41-44)	N/A	(45*)	(46*)	(47)**	(48**)
3	TTD	Mark III	9 (1-9)	N/A	31 (10-30, 32-40, 48)	4 (41-44)	N/A	(45*)	(46*)	(47)**	(31**)
4	TTD	Mark IV, LCDT	15 (1-15)	N/A	25 (16-40)	N/A	N/A	(45*)	(46*)	(47)**	(48**)
5	TTD	Mark IV, LCDT+	15 (1-15)	N/A	25 (16-40)	4 (41-44)	N/A	(45*)	(46*)	(47)**	(48**)
6	TTD	Generic	16 (1-16)	4 (17-20)	20 (21-40)	4 (41-44)	N/A	(45*)	(46*)	(47)**	(48**)
20	DD-20	Altronic	8 (10-17)	N/A	11 (20-27, 30-32)	N/A	N/A	(45*)	(46*)	N/A	N/A
40	DD-40	Altronic	16 (10-17, 20-27)	N/A	24 (30-37, 40-47, 1-8)	N/A	N/A	(45*)	(46*)	N/A	N/A

* - If Remote Reset and Remote Lockout are selected in SETUP 4, any previous setting on channel 45 and 46 will be overridden.

** - Channel 47 and 48 are defaulted to Class ESD which means they will override the Test function and shut down the unit. They can be changed if desired.

() - numbers in paranthesis indicate terminal/channel numbers. The number in front of the () is the number of points in that template.

Note: When using the Altronic DD20 or 40 Emulation in a non-tachometer TTD, the overspeed channel must be configured.

(G)

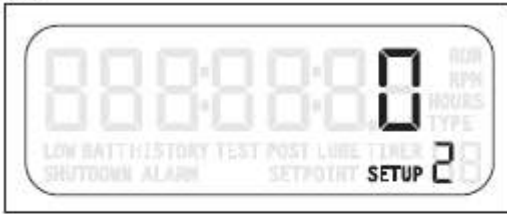

After selecting and saving a template, any channel can be reconfigured by changing a single channel in SETUP 3. To do this, return to SETUP 2 and enter 0 as the template setting (G). The point on the template originally selected is not changed with this action. Next, go to SETUP 3 and change channels, as necessary, to the preferred configurations.

(H)



Terminals 45 & 46 are enabled in SETUP 4 for Remote Reset and Remote Lockout functionality. If they are not enabled, they can be configured the same as the other channel. If they are enabled, they will override any previous setting. Remote Reset can only be used in terminal 45, and Remote Lockout can only be used in terminal 46.

(I)



Terminals 47 and 48 are defaulted to Class ESD. This means they will override the Test function and Shutdown the unit. The functionality on these channels can be changed, if desired.

When Template 20 is selected (H), the channel assignments will duplicate the DD20. Remaining channels are configured as inactive but can be modified in SETUP 3 once SETUP 2 is set to 0. This also applies to Template 40; with the exception of channels 50 to 57 that are assigned to TTD terminals 1 to 8.

If Template 20 or Template 40 is used in a unit without the tachometer option, the overspeed channel must be configured.

TTD Terminal Block Configuration NO/NC for DD-20

1	1	2	2	3	3	4	4	5	5	6	6	7	7	8	8	9	9	10	10	11	11	12	12
13	13	14	14	15	15	16	16	17	17	18	18	19	19	20	20	21	21	22	22	23	23	24	24
25	25	26	26	27	27	28	28	29	29	30	30	31	31	32	32	33	33	34	34	35	35	36	36
37	37	38	38	39	39	40	40	41	41	42	42	43	43	44	44	45	45	46	46	47	47	48	48

Class A Class B Class A

TTD Terminal Block Configuration NO/NC for DD-40

50 50 51 51 52 52 53 53 54 54 55 55 56 56 57 57

1	1	2	2	3	3	4	4	5	5	6	6	7	7	8	8	9	9	10	10	11	11	12	12
13	13	14	14	15	15	16	16	17	17	18	18	19	19	20	20	21	21	22	22	23	23	24	24
25	25	26	26	27	27	28	28	29	29	30	30	31	31	32	32	33	33	34	34	35	35	36	36
37	37	38	38	39	39	40	40	41	41	42	42	43	43	44	44	45	45	46	46	47	47	48	48

Class A Class B Class A

Setup 3 – Sensor Type



PASSWORD PROTECTED

Unit must be in Shutdown Mode to edit.

Individual sensor channel can be changed in SETUP 3 (A). As shown in the Sensor Types table, any channel can be set to one of the 11 available configurations. SETUP 2 must be set to 0 to make any changes in SETUP 3.

(A)



1. Press [SETUP/ENTER].
2. Use the [UP ARROW] key to increment and change the Channel number.
3. Press [SETUP/ENTER].
4. Use the [UP ARROW] key to select the Type (B).
5. Press [SETUP/ENTER] to SAVE the changes.

(B)



Sensor Types	
0	Class A
1	Class B1
2	Class B2
3	Class C
4	Class A Alarm
5	Class B1 Alarm
6	Class B2 Alarm
7	Class C Alarm
8	ESD
9	Ignore (Disabled)
10	Special Lockout*
11	Remote Reset**
12	Remote Lockout**
13	No-flow**

* Special Lockout is a fixed 5-minute timer. This timer starts at the same time as the B1 and B2 timers. While timing, the channel assigned this type is locked out. Unlike the B1 and B2 timers, this timer cannot be reset or zeroed while the unit is running. The timer is reset only after shutdown or normal stop.

Up to 48 dry contact sensor inputs or Murphy device transistor outputs can be connected to the TTD via a terminal block with 48 pair, screw type, each with a jumper for N.O. (Normally Open) or N.C. (Normally Closed) configuration.

** Settings represented as numbers for placeholders only. These values can only be set through other menu options in the TTD.

Setup 4 – Remote Reset Remote Lockout Select and No-Flow Enable Delay



(D)



Press the [ENTER] key to read SETUP 4A. Press a second time to read SETUP 4B.

(D) Use SETUP 4A to set the Remote Reset/Remote Lockout configuration of preselected channels 45 and 46.

(E)



(E) Remote Reset and Lockout are enabled by this setup and will override any template setting. When the Remote Reset feature is enabled, a closed contact on channel 45 resets the TTD annunciator in the same manner as when using the [RESET] key.

Limit close duration to 1 second. On models with lube option, Remote Reset will start the Prelube timer.

The Remote Lockout feature resets and inhibits the Class B1, B2 and C timers and fault inputs. Any faults configured as B1, B2 or C are ignored when channel 46 is an open contact. When the contact is closed, the timers will be allowed to time and arm the faults. This feature is intended to be used with automatic start/stop signals, typically connected to a run confirmation signal to enable the faults after running. Upon an auto-stop, the Remote Lockout should be re-activated by opening the channel 46 contact, until the next start auto-start signal.

With the unit running and an open contact on channel 46, the display will flash and display the B1 timer. On units with Tachometer, the display will flash and alternate between RPM reading and B1 timer.

Configuration Settings	
0	Disabled
1	Remote Reset assigned in the CH45 (fixed)
2	Remote Lockout assigned in the CH46 (fixed)
*3	Remote Reset assigned in the CH45 (fixed) and Remote Lockout assigned in the CH46 (fixed)

** If Remote Reset and Lockout are used simultaneously on models with Lube option, Prelube timer is only activated if the unit is faulted or in Manual Stop and receives the Remote Reset signal. The Remote Lockout signal only inhibits the Class B1 and B2 timers. Therefore Prelube timer is skipped if the system is already reset when the Remote Lockout is released.*

No-Flow Switch Transition Time

Use SETUP 4b through 4E to set No-Flow switch transition times.

Digital input channels 41 to 44 can be configured for detecting a transition of the switches on a divider block of a compressor system. The channels are scanned to determine if a transition has occurred in an acceptable time. The time range settings are from 0 to 59 seconds. (The default setting is zero.)

(G)



(G) SETUP 4b is the No-flow screen for CH41

(H) SETUP 4C is the No-flow screen for CH42

(I) SETUP 4d is the No-flow screen for CH43

(J) SETUP 4E is the No-flow screen for CH44

(H)



Setting the value to 0 (zero) on any channel will disable the No-flow function for that channel and allows SENSOR MODE (SETUP 2) or SENSOR TYPE (SETUP 3) to determine the Sensor channel functionality.

(I)



A non-zero value enables No-flow function for that channel and defines the timeout for the channel. Enabling No-flow function overwrites the channel SENSOR TYPE or SENSOR MODE configuration (reserves the channel only for No-flow use).

The Test Mode will be ignored if the No-flow is enabled for the channel.

(J)



Because these inputs are always in transition, the channels are always tested for open and close.

NOTE: Use SETUP 1 to configure (TMR7) Timer 7 delay before No-Flow shutdown.

Setup 5 - Hourmeters



PASSWORD PROTECTED

(K)



(K) This setup is for reading and/or resetting the hourmeter. There are two separate hourmeters:

Hourmeter 5A can be reset.

Hourmeter 5b is the TTD internal hourmeter and keeps track of total RUN HOURS.

(L)



(L) 5A Hourmeter Setting. Range 0 to 99999 hrs. (This hourmeter can be reset.)

(M) 5b Product Life Timer. Range 0 to 99999 hrs. (11.41 years non-stop. This hourmeter cannot be reset.) The Product Life Timer reading can also be accessed through the Modbus or via the Setup menu.

(M)



NOTE: The hourmeter registers are in the display head not in the power supply and are not reset by changing the power supply.

Setup 6 – Speed Calibration



(N)



The optional Tachometer functionality is configured in SETUP 6 (N).

Pulses per Revolution is calibrated as follows:

Press [SETUP/ENTER] to reach SETUP 6A (O).

(O)



Pressing [SETUP/ENTER] a second time increments the display to 6b.

SETUP 6A is the Pulses per Revolution Setting. Speed input can be either Magnetic pickup (MPU) or CD Ignition Primary Signal (IGN). The range is .5 to 450. Use the [UP ARROW] or [DOWN ARROW] keys to reach the desired setting. Use Settings .5-16.5 with ignition input

for speed, and settings 17-450 for magnetic pickup input (10 kHz max frequency input).

In the Conversion Table, the number of cylinders and cycles of the engine determine the number of pulses per revolution for ignition input. Divide the number of cylinders by 2 for split capacitor ignitions. Multiply the number of cylinders by 2 for throwaway spark ignitions.

Conversion Table		
Cylinders	Cycles	Pulses
1	2	1
2	2	2
2	4	1
3	2	3
4	2	4
4	4	2
5	2	5
6	2	6
6	4	3
8	2	8
8	4	4
10	4	5
12	4	6
16	4	8

(Q)



SETUP 6b (Q) is the RPM Filter Enable and Loss of Ignition selection and setting. Use the [UP ARROW] or [DOWN ARROW] keys to select a value. Choose a setting from the Loss of Ignition Shutdown and RPM Filter Table to choose a monitoring combination.

Value	Loss of Ignition Shutdown	RPM Filter
0 (default)	Enabled	Disabled
1	Disabled	Disabled
2*	Enabled	Enabled
3*	Disabled	Enabled

* If the TTD unit does not have the Tachometer option, only the 0 and 1 values are available.

Loss of Ignition Shutdown is a Class C function that can be armed only after the B1 Timer (TMR1) expires. When enabled and B1 Timer has expired, CD Ignition must be present (above 90VDC) for at least 15 seconds to arm the Loss of Ignition function. After being armed if CD Ignition falls below 90VDC for at least 15 seconds, the Shutdown sequence will begin, and code 49 will be displayed. (See *Fault Code table on page 19.*)

NOTE: The tolerance of the CD Ignition voltage detection is $\pm 10\%$. The arming and shutdown delay of 15 seconds is not adjustable.

RPM filter allows for a DEBOUNCE time before a loss of ignition, underspeed or overspeed shutdown occurs. The filter (when enabled) will take 3 more RPM readings (typically 500mS) once the threshold for shutdown has been achieved. If after these 3 attempts, the shutdown is still valid, a shutdown will occur. If the RPM reading has re-established at a valid state, the unit will remain running.

Setup 7 – Tachometer Overspeed Option



EDITING DURING RUN MODE ALLOWED

(A)



Fault Code 50. (See *Fault Code table on page 19.*)

(A) Use SETUP 7 to adjust the Overspeed Setting. The range is 0 to 5000 RPM.

(B) Press [ENTER] to view the Overspeed setting.

(B)



To change the setting, use the [UP ARROW] or [DOWN ARROW] keys to reach the new Overspeed setting and press [ENTER] to save the change.

NOTE: Overspeed is a Class A Type Shutdown and is not locked out or testable during Test Mode.

NOTE: For TTD-T models used with EICS G-Lead/U-Lead for tachometer readings, disable TTD overspeed and underspeed faults, or false shutdowns may occur caused by diagnostic signals sent by EICS on the G-Lead/U-Lead.

Setup 8 – Tachometer Underspeed Option



EDITING DURING RUN MODE ALLOWED

(C)



Fault Code 51. (See *Fault Code table on page 19.*)

(C) Use SETUP 8 to adjust the Underspeed Setting. The range is 0 to 5000 RPM.

(D) Press [ENTER] to view the Underspeed setting.

(D)



To change the setting, use the [UP ARROW] or [DOWN ARROW] keys to reach the new Underspeed setting and press [ENTER] to save the change.

NOTE: Underspeed is locked out by the B1 Timer (Timer 1). Underspeed will not cause a fault until the B1 timer expires.

NOTE: For TTD-T models used with EICS G-Lead/U-Lead for tachometer readings, disable TTD overspeed and underspeed faults, or false shutdowns may occur caused by diagnostic signals sent by EICS on the G-Lead/U-Lead.

Setup 9 – Communication Settings



EDITING DURING RUN MODE ALLOWED

(E)



(E) Use SETUP 9 to select ports, characteristics and communication values for remote devices. Use the [UP ARROW] and/or [DOWN ARROW] to reach setting.

(F)

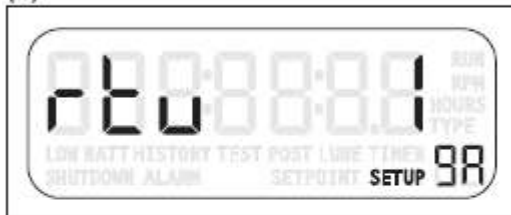

(F) This is the RTU (Remote Terminal Unit) setting. The range is 1 to 99 (Node number).

(G)



(G) This is the Port selection. There are two choices:

0 – RS485

1 – RS232

(H)



(H) This is the Baud rate selection. There are five choices:

0 - 9600,N,8,1

1 - 9600,N,8,2

2 - 19200,N,8,1

3 - 19200,N,8,2

4 - 38400,N,8,1 (only if the pulses/rev setting is greater than 16.5)

5 - 38400,N,8,2 (only if the pulses/rev setting is greater than 16.5)

Setup A – Output Mode

 **PASSWORD PROTECTED**



Upon Shutdown, the FV- (Fuel Valve minus) and the RLY (Relay) terminals change state and either conduct to ground or open to ground. The change of state depends on the configuration of SETUP A.

There are four choices (terminals are shown in shut-down state):

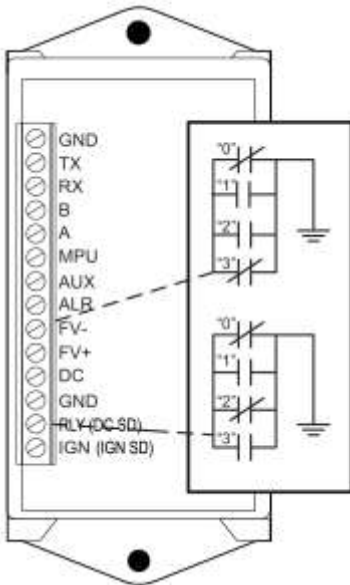

Shutdown Mode					
Output Mode	IGN Kill	RELAY	FV-	ALR	AUX
0	Closed	Closed	Closed	Closed - alarm event Open - no event	Open
1	Open*	Open	Open	Closed - alarm event Open - no event	Open
2	Closed	Closed	Open	Closed - alarm event Open - no event	Open
3	Open*	Open	Closed	Closed - alarm event Open - no event	Open

Table Note: Closed indicates a closed-to-ground state and open indicates an open-to-ground state when the TTD unit is in Shutdown Mode.

Open* -- These outputs do not change state during a run mode — they remain open. Typically used with IGN as a speed input only and the application does not require grounding ignition on a unit fault.

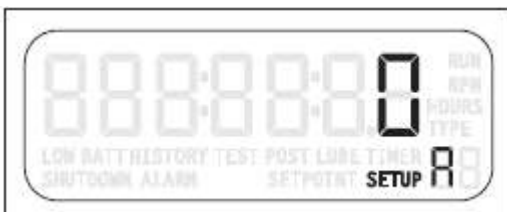

Use the [UP ARROW] or [DOWN ARROW] key to select the Output Mode setting. Press [ENTER] to save the setting.

Setup B – Unit Identification (ID)



EDITING DURING RUN MODE ALLOWED

(L)



(L) This function enables the operator to assign a six-digit number.

Use the [UP ARROW] arrow key to increment to the SETUP B option.

(M)



(M) Press [SETUP/ENTER] to access the Prefix screen and the [UP ARROW] or [DOWN ARROW] keys to set the Prefix ID. The Range is 0 to 99.

Press [ENTER] to save the selection and the (N) Suffix ID screen displays. Use the [UP ARROW] or [DOWN ARROW] keys to set the Suffix ID. The range is 0 to 9999.

(N)



Setup C – Factory Default



(A)



(A) This option returns all settings except the Product Life Time register back to the default Factory settings.

Use these instructions to return the TTD unit to the original factory defaults:

1. Enter the correct numeric password. (B)
2. Use the [UP ARROW] key to set the value to 1 (C).
3. Press the [SETUP/ENTER] key to save the change. The screen display returns to SETUP C.
4. Press the [DOWN ARROW] to reach SETUP 0.
5. Press [ENTER]
6. The EEPF screen displays to verify the factory defaults have been reinstated. (D)

(B)



(C)



(D)



CAUTION: Executing SETUP C resets all settings, registers and hours. Shut-down and alarm histories will also be erased.

Voltage Readings

(E)



(E) The internal backup battery, external DC and ignition voltage readings are available in the VOLT menu after SETUP C. These readings are updated approximately every 4 seconds and are read-only.

Press the [ENTER] key to view each of the readings:

(F)



- Internal Backup Battery voltage (F)

Press the [ENTER] key to set the Internal Backup Battery **Low Voltage Alarm**. Press the up/down arrow keys to enable (1), to disable return to 0. Press [ENTER].

(G)



- External DC (G)

Press the [ENTER] key to set the External DC **Low Voltage Alarm**. Press the up/down arrow keys to the desired voltage. Press [ENTER].

(H)



- Ignition Voltage peak (H)

If the ignition is wired to the TTD unit.

If Internal Backup Battery, External DC and CD Ignition are connected and operational, power for the TTD Annunciator has the following priority:

1. External DC is used unless voltage falls below 9VDC.
2. CD Ignition is used unless peak voltage falls below 90VDC.
3. Internal Backup Battery is used when no other voltage is present.

NOTE: The TTD Annunciator will operate normally under Internal Backup Battery power except communication functions and backlight will be disabled.

If Underspeed and/or Loss of Ignition are enabled, the TTD may shut down when CD Ignition is not present. The tolerance for CD Ignition detection is $\pm 10\%$.

Software Version

(I)



The Version menu (I) offers a quick and easy way to check the firmware versions in the TTD components.

To verify the current firmware, press [ENTER] to access the Version SETUP H or SETUP P. Press [ENTER] the first time to view SETUP H. Pressing [ENTER] a second time reaches SETUP P.

(J)



SETUP H indicates the software version in the Display Head. In this sample (J), the version is 8.0. (Read 8 point 0)

SETUP P indicates the software version in the Power Supply. In this sample (K), the version is 8.2. (Read 8 point 2)

(K)



Communications

Communications Port

A single bi-color (GREEN/RED) LED will be provided to give visual indication of active transmit and receive traffic.

Interface: Factory configured for RS485; field-selectable for RS232 or RS485

Baud/Configuration: 9600, 19.2K, 38.4K (*); N,8,1;N,8,2 half-duplex communication (set-up configuration is in SETUP 9)

Protocol: Modbus RTU Slave (*)

() The TTD responds to Modbus RTU Read Holding Registers request (Function Code 03). Reads can be up to 50 registers per request. An attempt to read over 50 will return an exception code. When the TTD is on the same RS485 network with other devices, a minimum 125mS poll delay must be used between each device on the network or time outs will occur from the TTD. The Modbus RTU master should be configured to use retries on the TTD, and typical timeout setting for the TTD should be 500mS or greater.*

Connection: There will be 2 screw terminals provided for RS485.

These will be printed or labeled as A and B. A is the non-inverting (+) signal. B is the inverting (-) signal.

There will be 3 screw terminals provided for RS232.

These will be printed or labeled as RX, TX and GND. RX is the receive signal, TX is the transmit signal and GND is the signal ground reference.

() 38.4K Baud will not be available when IGN input is selected as the source for RPM calculations. When MPU is selected, this feature is available for selection.*

Modbus Register Address Listings

Address	Description	Type	Min Value	Max. Value	Default Value
40,001	RPM	R	-	-	-
40,002	ETM (Elapsed Time Meter 0-65535 Hrs.) (*)	R	-	-	-
40,003	Class B1 Timer (secs.)	R	-	-	-
40,004	Shutdown Code	R	-	-	-
40,005	Output Status Bit Map Bit 0 – Ignition (1 ground, 0 ungrounded) Bit 1 – Fuel Valve (1 ground, 0 ungrounded) Bit 2 – Alarm (1 ground, 0 ungrounded) Bit 3 – Pre/Post Lube (1 ground, 0 ungrounded) Bits 4, 5, 6 and 7 – N/A	R	-	-	-
40,006	Inputs 1-16 Status Bit Map	R	-	-	-
40,007	Inputs 17-32 Status Bit Map	R	-	-	-
40,008	Inputs 33-48 Status Bit Map R	R	-	-	-
40,009	Class B2 Timer (secs.)	R	-	-	-
40,010	Test Timer (secs.)	R	-	-	-
40,011	Ignition Ground Timer (secs.)	R	-	-	-
40,012	PreLube Timer (secs.)	R	-	-	-
40,013	PostLube Timer (secs.)	R	-	-	-
40,014	No-Flow Timer (secs.)	R	-	-	-
40,015	TTD-H SPI (diagnostic use only)	R	-	-	-
40,016	PS-TTDH Sync. Flag	R	-	-	-
40,017	TTD-P SPI (diagnostic use only)	R	-	-	-
40,018	Battery Voltage x10	R	-	-	-
40,019	External DC Voltage x10	R	-	-	-
40,020	Ignition Voltage x10	R	-	-	-
40,021	B1 Timer Setting (TMR1)	R/W**	0	300	300
40,022	B2 Timer Setting (TMR2)	R/W**	0	599	599
40,023	Ignition Timer Setting (TMR4)	R/W**	0	20	3
40,024	PreLube Timer Setting (TMR5)	R/W**	0	300	300
40,025	PostLube Timer Setting (TMR6)	R/W**	0	599	599
40,026	Sensor Mode Setting	R/W*	0	40	1
40,027	Input Type #01	R/W*	0	10	0
40,028	Input Type #02	R/W*	0	10	0
40,029	Input Type #03	R/W*	0	10	0
40,030	Input Type #04	R/W*	0	10	0
40,031	Input Type #05	R/W*	0	10	0
40,032	Input Type #06	R/W*	0	10	0
40,033	Input Type #07	R/W*	0	10	0
40,034	Input Type #08	R/W*	0	10	0

(*) Hours greater than 65535 will rollover to 0. This is a 16-bit limit of the register; however, the TTD supports up to 99,999 hours.

* Only accept Modbus write register(s) during Shutdown Mode.

** Accept Modbus write register(s) during Run and Shutdown Modes.

Modbus Register Address Listings (continued)

Address	Description	Type	Min Value	Max. Value	Default Value
40,035	Input Type #09	R/W*	0	10	0
40,036	Input Type #10	R/W*	0	10	0
40,037	Input Type #11	R/W*	0	10	0
40,038	Input Type #12	R/W*	0	10	0
40,039	Input Type #13	R/W*	0	10	0
40,040	Input Type #14	R/W*	0	10	0
40,041	Input Type #15	R/W*	0	10	0
40,042	Input Type #16	R/W*	0	10	0
40,043	Input Type #17	R/W*	0	10	0
40,044	Input Type #18	R/W*	0	10	0
40,045	Input Type #19	R/W*	0	10	0
40,046	Input Type #20	R/W*	0	10	0
40,047	Input Type #21	R/W*	0	10	0
40,048	Input Type #22	R/W*	0	10	0
40,049	Input Type #23	R/W*	0	10	0
40,050	Input Type #24	R/W*	0	10	0
40,051	Input Type #25	R/W*	0	10	0
40,052	Input Type #26	R/W*	0	10	0
40,053	Input Type #27	R/W*	0	10	0
40,054	Input Type #28	R/W*	0	10	0
40,055	Input Type #29	R/W*	0	10	0
40,056	Input Type #30	R/W*	0	10	0
40,057	Input Type #31	R/W*	0	10	0
40,058	Input Type #32	R/W*	0	10	0
40,059	Input Type #33	R/W*	0	10	0
40,060	Input Type #34	R/W*	0	10	0
40,061	Input Type #35	R/W*	0	10	0
40,062	Input Type #36	R/W*	0	10	0
40,063	Input Type #37	R/W*	0	10	0
40,064	Input Type #38	R/W*	0	10	0
40,065	Input Type #39	R/W*	0	10	0
40,066	Input Type #40	R/W*	0	10	0
40,067	Input Type #41	R/W*	0	10	0
40,068	Input Type #42	R/W*	0	10	0
40,069	Input Type #43	R/W*	0	10	0
40,070	Input Type #44	R/W*	0	10	0
40,071	Input Type #45	R/W*	0	10	0
40,072	Input Type #46	R/W*	0	10	0
40,073	Input Type #47	R/W*	0	10	0
40,074	Input Type #48	R/W*	0	10	0
40,075	Remote Reset / Remote Lockout Setting	R/W*	0	3	0
40,076	Hours Setting	R/W*	0	65535(*)	0
40,077	Pulses Per Revolution Setting x10	R/W*	5	4500	60
40,078	RPM Filter/Loss of Ignition Setting	R/W*	0	3***	0
40,079	Overspeed Setting	R/W**	0	5000	1000
40,080	Underspeed Setting	R/W**	0	5000	100
40,081	Output Mode Setting	R/W*	0	3	0
40,082	ID- Prefix	R/W**	0	99	0
40,083	ID- Suffix	R/W**	0	9999	0
40,084	Password	R/W**	0	99	-

(*) Hours greater than 65535 will rollover to 0. This is a 16-bit limit of the register; however, the TTD supports up to 99,999 hours.

* Only accept Modbus write register(s) during Shutdown Mode.

** Accept Modbus write register(s) during Run and Shutdown Modes.

*** Range is 0 to 1 for non-Tachometer models. (See SETUP 6 - SPEED CALIBRATION section for details).

Modbus Register Address Listings (continued)

Address	Description	Type	Min Value	Max. Value	Default Value
40,085	Test Timer Setting (TMR3)	R/W**	-0	300	300
40,086	Life Timer	R	-	-	-
40,087	TTD-H Firmware x10	R	-	-	-
40,088	PSU-X Firmware x10	R	-	-	-
40,089	PSU Type 120 - Base Model + No Flow 121 - Base Model + Tach + No Flow 122 - Base Model + Lube + No Flow 123 - Base Model + Tach + Lube + No Flow 124 - Base Model 125 - Base Model + Tach 126 - Base Model + Lube 127 - Base Model + Tach + Lube	R	-	-	-
40,090	OSC Calibration	R	-	-	-
40,091	PSU Power-up (PUR or WDT)	R	-	-	-
40,092	PSU Update History Shutdown Data	R	-	-	-
40,093	No-Flow Timer Setting (TMR7)	R/W**	0	599	0
40,094	CH41 TON/OFF	R/W*	0	59	0
40,095	CH42 TON/OFF	R/W*	0	59	0
40,096	CH43 TON/OFF	R/W*	0	59	0
40,097	CH44 TON/OFF	R/W*	0	59	0
40,098	Low DC Voltage Alarm	R/W**	0	32	0
40,099	Low Backup Battery Alarm	R/W**	0	1	0
40,100	N/A	R	-	-	-
40,101	SD History #1	R	-	-	0
40,102	ETM @ SD1	R	-	-	0
40,103	SD History #2	R	-	-	0
40,104	ETM @ SD2	R	-	-	0
40,105	SD History #3	R	-	-	0
40,106	ETM @ SD3	R	-	-	0
40,107	SD History #4	R	-	-	0
40,108	ETM @ SD4	R	-	-	0
40,109	SD History #5	R	-	-	0
40,110	ETM @ SD5	R	-	-	0
40,111	SD History #6	R	-	-	0
40,112	ETM @ SD6	R	-	-	0
40,113	SD History #7	R	-	-	0
40,114	ETM @ SD7	R	-	-	0
40,115	SD History #8	R	-	-	0
40,116	ETM @ SD8	R	-	-	0
40,117	SD History #9	R	-	-	0
40,118	ETM @ SD9	R	-	-	0
40,119	SD History #10	R	-	-	0
40,120	ETM @ SD10	R	-	-	0
40,121	Alarm History #1	R	-	-	0
40,122	ETM @ AL1	R	-	-	0
40,123	Alarm History #2	R	-	-	0
40,124	ETM @ AL2	R	-	-	0
40,125	Alarm History #3	R	-	-	0
40,126	ETM @ AL3	R	-	-	0
40,127	Alarm History #4	R	-	-	0
40,128	ETM @ AL4	R	-	-	0

* Only accept Modbus write register(s) during Shutdown Mode.

** Accept Modbus write register(s) during Run and Shutdown Modes.

*** Range is 0 to 1 for non-Tachometer models. (See SETUP 6 - SPEED CALIBRATION section for details).

Specifications

Power Requirements

PSU-2: 10-32VDC, 10W (max); 90-400VDC CD Ignition, 750uA @ 100VDC (max)

On-Board Backup Power: Lithium battery, 6 VDC, 1300 mAh

Digital Inputs: 48 (a.k.a. Channels)

Sensor Types: Discrete Input, N.O. / N.C., non-incendive (with use of PSU-2)

Magnetic Pickup Input

One Magnetic Pickup Sensor Input: 3.6 - 120 VAC, 2-10 kHz

Outputs

IGN: 0.4A @ 400VDC (*) for 5 seconds

RLY: 0.5A @ 48VDC cont. duty

0.15A @ 400VDC (*) cont. duty

FV- : 0.5A @ 400VDC (*) cont. duty

ALR: 0.5A @ 48VDC cont. duty

AUX: 0.5A @ 48VDC cont. duty

(*) CSA approval for 250VDC maximum

Operator Interface

Display Type: LCD, Static, 80 segment, custom text with LED Backlight

Display Viewable Area: ~ 2.79 x 1 in. (71.04mm x 25.4mm)

Display Contrast: Automatic

Display Backlight: Yellow (Normal Operation), Red (Shutdown)

(Backlight will only be available when unit is powered by DC or AC.)

Voltage Level Monitor: Monitor and display voltage level of DC Supply, CD Ignition and internal battery

Keypad: 6 switches: Ridge Embossed, Metal Dome, Tactile 14 Oz. Trip Force

Enclosure Cutout: 5.50 x 5.50 inches (133 mm)

Operating Temperature: -40 to +85 degrees C

Viewable Temperature: -40 to +85 degrees C

Storage Temperature: -40 to +85 degrees C

Tachometer Accuracy: $\pm 0.5\%$ of the display reading or ± 1 RPM, whichever is greater

Resetable Hourmeter Range: 0 to 99999 hrs.

Non-Resetable Hourmeter Range: 0 to 99999 hrs.

Hourmeter Accuracy: ± 1 hour per year

Specifications (continued)

Communication Port

A single bi-color (GREEN/RED) LED is provided to give visual indication of active transmit and receive traffic

Interface: Factory configured for RS485; field-selectable for RS232 or RS485

Baud/Configuration: 9600, 19.2K, 38.4K (**); N, 8, 1; N, 8, 2 half-duplex communication

Protocol: Modbus RTU slave

Connection: There will be 2 screw terminals provided for RS485

There will be 2 screw terminals provided for RS232

There will be 1 screw terminal common for both ports labeled as GND

*(**) 38.4K baud will not be available when IGN input is selected as the source for RPM calculations. When MPU is selected, this feature is available for selection*

Third Party Approvals

TTD-H, PSU-2: CSA Class I, Division 2, Groups B, C, and D

TTD-H: IEC 60529 – IP66 (NEMA 4 and 4X equivalent)

Intuitive Display Icons

Display status and assist in setup and operation resulting in greater ease of operation and interface. The appropriate icon will turn on to indicate unit status or navigation through the set-up features.

RUN - Run mode

RPM – Screen Value

HOURS – Screen Value

TYPE – Channel Type Configuration

LOW BATT – Low Battery Warning (displayed only when condition exists)

HISTORY – Shutdown History

TEST – Test Mode

LUBE – Pre-lubrication Timer

POSTLUBE – Post-lubrication Timer

SHUTDOWN – Stop Mode

ALARM – Alarm(s) Warning (displayed only when condition exists)

SETPOINT – Edit Set-point Value

SETUP – Setup Menu(s)

TTD Replacement Parts and Assemblies

Part Number	Description	Notes
50700597	TTD-H Display Head	Replacement Parts and Assemblies
50700596	PSU-2 Div 2 Power Supply	
50700594	PSU-2-T Div 2 Power Supply w/ Tach	
50700944	PSU-2-L-N Div 2 Power Supply w/Pre/Post Lube and No-Flow	
50700942	PSU-2-T-L-N Div 2 Power Supply w/ Tach, Pre/Post Lube and No-Flow	
00005125	Backup Lithium Battery, 6VCD, 1200mAh	
50000774	Ignition Choke Filter	
00009741	TTD-H Plug Kit, Printed Replacement Terminal Plugs for TTD-H Sensor Inputs	
00009768	PSU-2-Plug, Printed Replacement Plug for PSU-2 Power Connector	Configuration Software
53702325	RS485 toUSB Interface Kit (53702325): To configure TTD using Mconfig™ software and PC over USB port	

In order to consistently bring you the highest quality, full-featured products, we reserve the right to change our specifications and designs at any time. MURPHY products and the Murphy logo are registered and/or common law trademarks of Enovation Controls, LLC. This document, including textual matter and illustrations, is copyright protected by Enovation Controls, LLC, with all rights reserved. (c) 2016 Enovation Controls, LLC. A copy of the warranty may be viewed or printed by going to www.fwmurphy.com/warranty.

ENOVATION CONTROLS CORPORATE HEADQUARTERS

5311 S 122ND EAST AVENUE
TULSA, OK 74146

ENOVATION CONTROLS – SAN ANTONIO OFFICE

5757 FARINON DRIVE
SAN ANTONIO, TX 78249

ENOVATION CONTROLS – HOUSTON OFFICE

105 RANDON DYER RD
ROSENBERG, TX 77471

ENOVATION CONTROLS LTD. – UNITED KINGDOM

CHURCH ROAD LAVERSTOCK
SALISBURY SP1 1QZ UK

MURPHY ECONTROL TECHNOLOGIES (HANGZHOU) CO, LTD.

77 23RD STREET
HANGZHOU ECONOMIC & TECHNOLOGICAL DEVELOPMENT AREA
HANGZHOU, ZHEJIANG 310018 CHINA

U.S. SALES & SUPPORT

ECONTROL PRODUCTS

PHONE: 210 495 9772
FAX: 210 495 9791
EMAIL: INFO@ENOVATIONCONTROLS.COM
WWW.ECONTROL.COM

MURPHY PRODUCTS

PHONE: 918 317 4100
FAX: 918 317 4266
EMAIL: SALES@ENOVATIONCONTROLS.COM
WWW.FWMURPHY.COM

MURPHY CONTROL SYSTEMS & SERVICES

PHONE: 281 633 4500
FAX: 281 633 4588
EMAIL: CSS-SOLUTIONS@ENOVATIONCONTROLS.COM

MURPHY INDUSTRIAL PANEL DIVISION

PHONE: 918 317 4100
FAX: 918 317 4124
EMAIL: IPSALES@ENOVATIONCONTROLS.COM

INTERNATIONAL SALES & SUPPORT

UNITED KINGDOM

PHONE: +44 1722 410055
FAX: +44 1722 410088
EMAIL: SALES@ENOVATIONCONTROLS.EU
WWW.FWMURPHY.EU

CHINA

PHONE: +86 21 6237 5885
FAX: +86 21 6237 5887
EMAIL: APSALES@ENOVATIONCONTROLS.COM

LATIN AMERICA & CARIBBEAN

PHONE: 918 317 2500
EMAIL: LASALES@ENOVATIONCONTROLS.COM

SOUTH KOREA

PHONE: +82 70 7951 4100
EMAIL: SKOREASALES@ENOVATIONCONTROLS.COM

INDIA

PHONE: +91 91581 37633
EMAIL: INDIASALES@ENOVATIONCONTROLS.COM



FM 28221 (Tulsa, OK - USA)
FM 626667 (San Antonio, TX - USA)
FM 28221 (Rosenberg, TX - USA)
FM 29422 (UK)



FM 323851 (China) TS 589322 (China)